





Urbania sliding patio door, 95½" × 95½" painted black with black Studio handle

Urbania & Loft Aluminum Patio Doors

Courage changes everything. Our engineers had the courage to question everything and reinvent the aluminum patio door. A seamless vision between interior and exterior, with effortless operation, that brings color and design into your world — *that* is Urbania and Loft.

Panoramic View

Today's architectural trends follow the notion that the outdoors is an essential extension of the living space. Bright and open floor-to-ceiling windows have replaced large cumbersome structures expanding the limits of architectural freedom. With wider panels and fewer frame elements, Urbania & Loft provide a large glass surface that open up your home.

Effortless Operation — A Sense of Quality!

High precision machined wheels and the available lift & slide mechanism make sliding oversized panels nearly frictionless. Each detail is designed to make opening and closing simpler and more enjoyable.

Exceptional Comfort and Energy Efficiency

Composite thermal barriers and an innovative sealing system combine to offer the highest performance ratings on the market. Urbania and Loft can be installed in Energy Star zones 1, 2, or 3 without restrictions.

Durable and Maintenance Free

Does a robust door need heavy looking structures? The Urbania and Loft aluminum frames are minimalist in your line of sight yet engineered with the utmost structural integrity to withstand wind loads, shocks, and the toughest climates from -30°C to 72°C.

Security and Peace of Mind

Stronger means safer. Solid aluminum frames with fibre reinforced thermal barriers make the most solid doors you can install. Standard double-point locking system on the Urbania sliding door — standard triple-point locking system on Loft lift-&-slide door.





Loft lift-&-slide patio door, 119" x 95½" painted black with brushed chrome Kora handle

The Loft patio door designed to be larger than life!

Loft extends your living space into the outdoors. Its lifting mechanism ensures large glass panels are easy and simple to move while providing unparalleled airtightness when closed. Two panel configurations — in lieu of three or four panel — define contemporary lifestyle and breathtaking atmosphere. Safe, durable, easy to operate and energy efficient, this door is the best from Novatech.



One System,
Two Doors

Urbania

Sliding Patio Door

Personalize and customize your Urbania door through contemporary or classic handles, multiple color and glass options.

- Glass surfaces that create an ambiance
- Double-point locking system for top security
- Standard Low E Argon sealed units
- High quality corrosion resistant tandem wheels

Loft





Lift & Slide Patio Door

Loft brings you the performance and beauty of Urbania and more. Its lift & slide mechanism allows greater architectural flexibility and configurations typically reserved for folding doors or other, more complex systems.

- Height and width like never before
- Triple-point locking system for top security
- Standard Low E Argon sealed units
- High quality corrosion resistant tandem wheels

Configurations

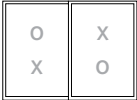
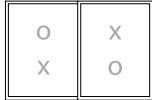
Exterior view.
X = Opening Panel.
O = Fixed Panel.

	5'	6'	8'	9'	10'	12'
						
Urbania	59½" × 79½" 58½" × 81" 59½" × 95½"	71½" × 79½" 70½" × 81" 71½" × 95½"	95½" × 79½" 94½" × 81" 95½" × 95½"	107" × 79½" 107" × 81" 107" × 95½"		
Loft		71½" × 79½" 70½" × 81" 71½" × 95½"	95½" × 79½" 94½" × 81" 95½" × 95½"	107" × 79½" 107" × 81" 107" × 95½"	119" × 79½" 119" × 81" 119" × 95½"	143" × 79½" 143" × 81" 143" × 95½"

Available
Colors

Two scratch resistant standard colors. Custom colors available on demand.



White K-1285



Black K-90421

Hardware

Urbania



Studio handle with double-point mortise (Standard)

Inside and outside handles shown. Keyed Lock option available.

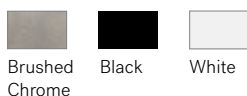

Brushed Chrome

Black

White



Signature handle with double-point mortise (Option)

Inside and outside handles shown. Keyed Lock option available.

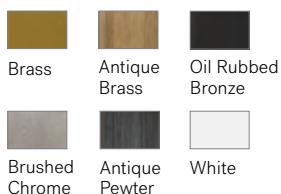

Brass

Antique Brass

Oil Rubbed Bronze

Brushed Chrome

Antique Pewter

White

Loft



Kora lift-&-slide handle with triple-point mortise (Standard)

Inside and outside handles shown.

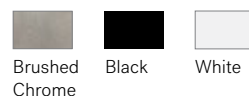

Brushed Chrome

Black

White

Options

Configuration Options

Custom sizes
 Custom colors
 1 ¼" Triple sealed insulated glass

Accessory Options

Grids
 Keyed lock (Urbania)
 Ultra-resistant screen with 3" aluminum frame
 Stainless Steel double-point locking mechanism (Urbania)

Installation Options

Frame width: 6", 7 ¼", 8", ou 9 ¼"
 Nailing fin (width behind nailing fin: 4 ⅞", ou 6 ⅞")
 Aluminum brick moulding
 Interior drywall moulding
 Sill extension

Available Soon

3 or 4 light option
 Sidelites and transoms
 Integrated blinds — white or satin grey
 Keyed lock (Loft)
 Security bar
 Retractable NovaScreen
 Knocked down kit

Performance

Reference: 95 ½" x 95 ½" door

	Double glazed with one Low E 80/70 glass	Triple glazed with one Low E 80/70 glass
U Value	1.87 W/m ² K	1.53 W/m ² K
Energy Rating	31	35
Energy Star Zone	1, 2	1, 2, 3

Air: A3

Water: DP 50 (360 Pa)

Structural: LC 40 without reinforcement, CW 60 with reinforcement.

Condensation Resistance Index: I = 53

Thermal Cycling tested ranging from -30 to 72 °C

Frame Configurations

Multiple configurations to simplify installation for various wall depths.

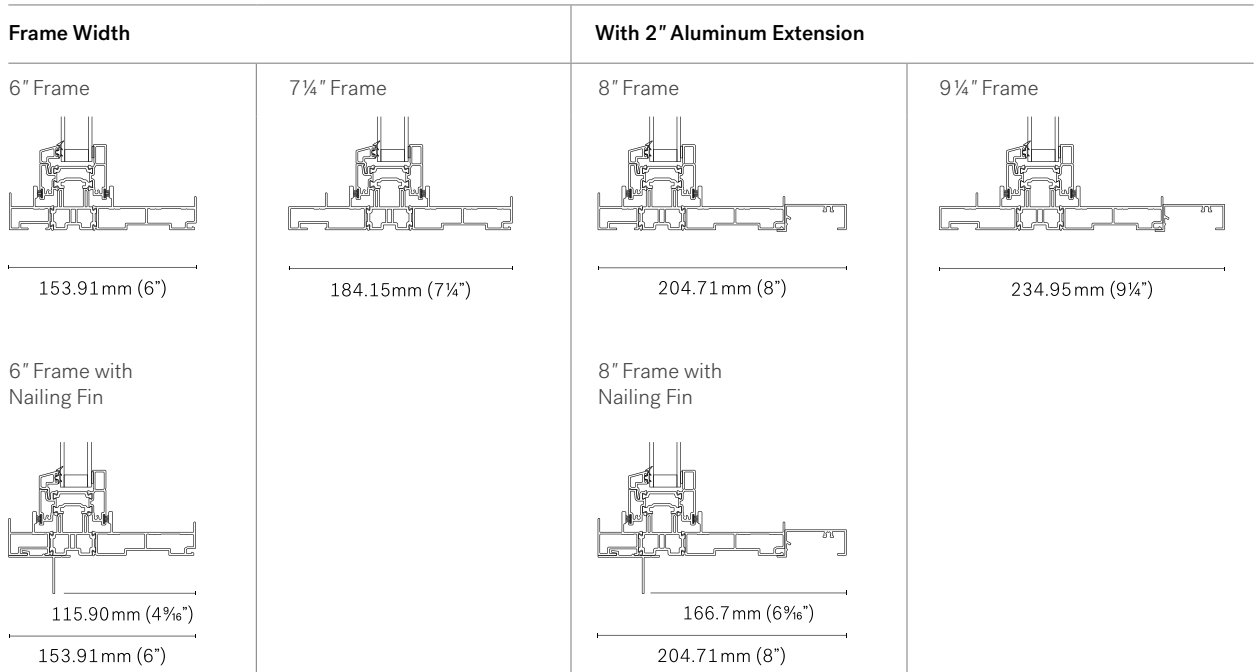

Canada

Novatech Head Office

Sainte-Julie, Quebec
160 Murano
J3E 0C6

Novatech Showroom

Sainte-Julie, Quebec
1401 Nobel
J3E 1Z4
Tel: 1-844-986-8001

Novatech Patio Doors

Beauceville, Quebec
100, 181th street
G5X 2T1

Toronto Office and Showroom

Toronto, Ontario
2070 Codlin Crescent,
Unit 1, M9W 7J2

Calgary Office and Showroom

Calgary, Alberta
5505, 72nd Avenue SE,
Unit 17, T2C 3C4

United States

Novatech USA

Ridgeway, Virginia
180 Textile Drive
24148
infoUSA@novatechgroup.com

France

Novatech Europe

Roanne, France
8 quai du Canal, BP83
42 302

Novatech[®]

novatechgroup.com

Toll Free: 1-866-886-2215

Customer Service #1

quotesppn@novatechgroup.com

ordersppn@novatechgroup.com

Technical Service #2

savppn@novatechgroup.com

